

X (2:1)

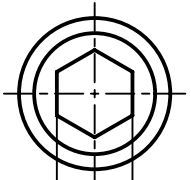

SW 5
tightening torque
min. 4Nm

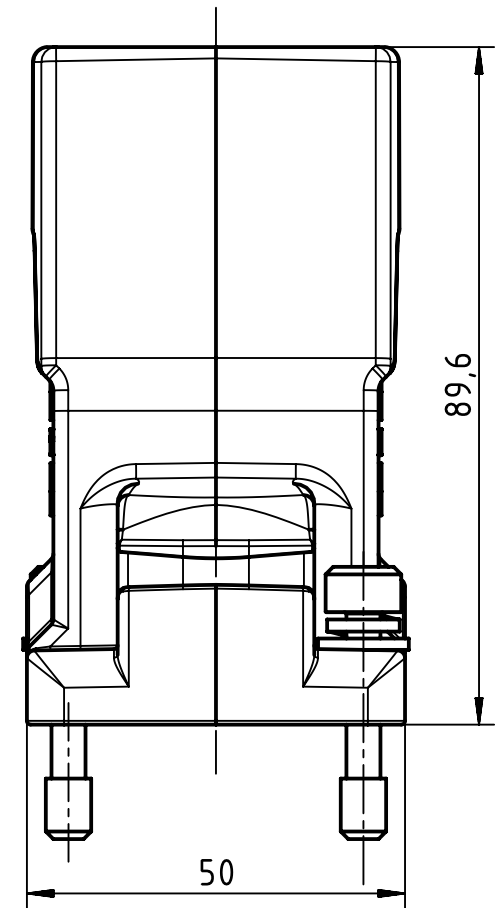
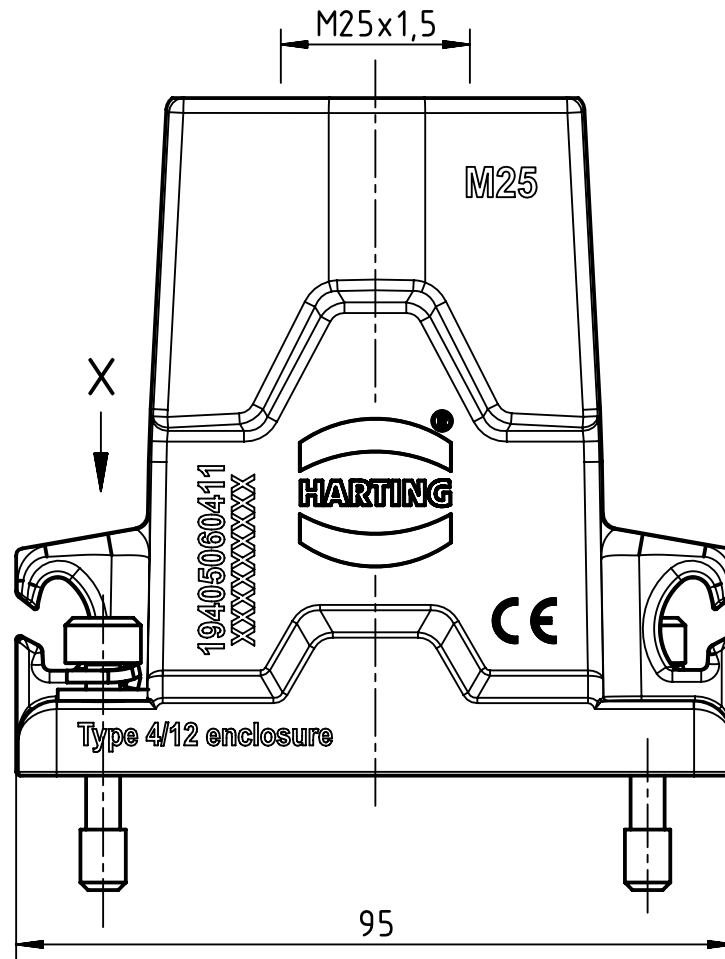
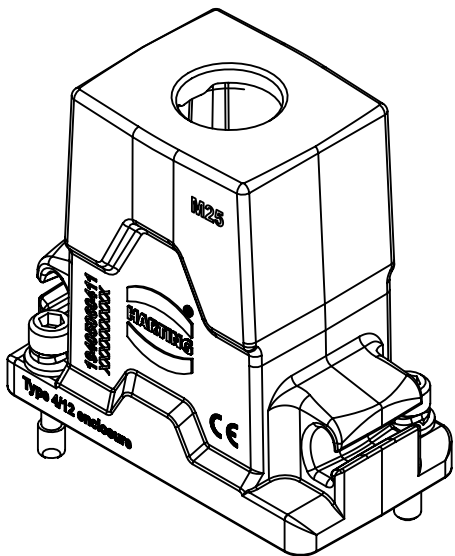

	All Dimensions in mm Original Size DIN A4		Scale 1:1	Free size tol.		Ref.	
			Created by WENE	Inspected by LUOK	Standardisation 302077	Date 2021-06-04	State Final Release
All rights reserved Department EL PD		Title Han 6HPR-Compact-HTE-HC-SCL-M25				Doc-Key / ECM-Nr. 100871534/UGD/001/C 500000196202	
HARTING D-32339 Espelkamp		Type TB	Number 19 40 506 0411			Rev. C	Page 1/1